

Pluggable Multi-Pole SPD for DC Systems  
**SafeTec T2-1000DC-3+0(-R)**  
 Type 2 • Type 4CA



Location of Use: DC Systems, EV Chargers  
 Mode of Protection: (+) - GND, (-) - GND, (+) - (-)  
 EN/UL Category: Type 2 / Type 4CA  
 Technology: Hybrid  
 Leakage Current Free: Yes  
 Housing: Pluggable Design  
 Safety: Patented Current Limiting  
 Compliance: UL 1449 4<sup>th</sup> Edition

**Technical Data**

**SafeTec T2-1000DC-3+0(-R) 1000**

EN Electrical		
Nominal DC Voltage	$U_n$	900 V
Maximum Continuous Operating Voltage (DC)	(+) - (-) $U_{CDC}$	1000 V
	(+/-) - G $U_{CDC}$	500 V
Nominal Discharge Current (8/20 $\mu$ s)	$I_n$	20 kA
Total Discharge Current	$I_{Total}$	65 kA
Voltage Protection Level	(+/-) - G $U_p$	2500 V
	(+) - (-) $U_p$	4800 V
Response Time	(+/-) - G $t_A$	< 100 ns
	(+) - (-) $t_A$	< 25 ns
Number of Ports		1

UL Electrical		
Maximum Permitted DC Voltage	$V_{dcmcov}$	1000 V
Measured Limiting Voltage	(+/-) - G $MLV$	2470 V
	(+) - (-) $MLV$	4590 V
Nominal Discharge Current (8/20 $\mu$ s)	$I_n$	20 kA





Mechanical & Environmental		
Operating Temperature Range	$T_a$	-40 °F to +185 °F [-40 °C to +85 °C]
Permissible Operating Humidity	RH	5%...95%
Altitude (max)		13123 ft [4000m]
Terminal Screw Torque	$M_{max}$	39.9 lbf-in [4.5 Nm]
Conductor Cross Section (max)		2 AWG (Solid, Stranded) / 4 AWG (Flexible)
		35 mm <sup>2</sup> (Solid, Stranded) / 25 mm <sup>2</sup> (Flexible)
Mounting		35 mm DIN Rail, EN 60715
Degree of Protection		IP 20 (built-in)
Housing Material		Thermoplastic: Extinguishing Degree UL 94 V-0
Thermal Protection		Yes
Operating State / Fault Indication		Green Flag / Not Green Flag
Remote Contacts (RC)		Optional
RC Switching Capacity		AC: 250V/1A, 125V/1A; DC: 48V/0.5A, 24V/0.5A, 12V/0.5A
RC Conductor Cross Section (max)		16 AWG (Solid) / 1.5 mm <sup>2</sup> (Solid)

Order Information	
Order Code	<b>1000</b>
SafeTec T2-1000DC-3+0	59.0373
SafeTec T2-1000DC-3+0-R (with remote contacts)	59.0374

## SafeTec T2-1000DC-3+0(-R)

### Internal Configuration

#### Legend

-  PE/G Conductor Terminal
-  RC Remote Contacts Terminal (Optional)
-  TC Thermal Control Function
-  TD Thermal Disconnecter

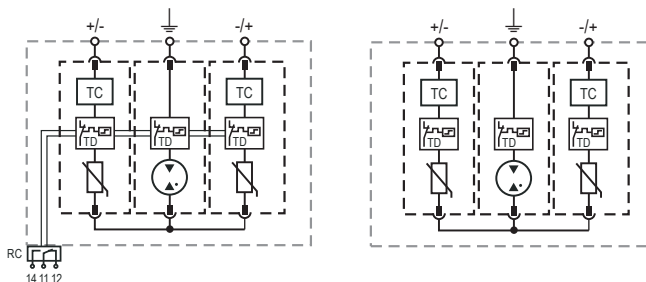

### Complete Unit

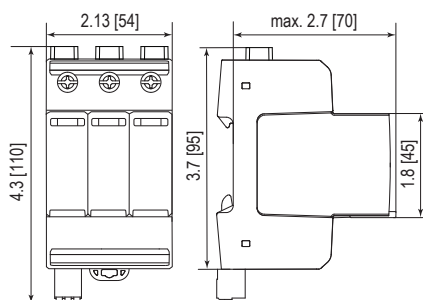

#### Complete Unit Dimensions & Packaging

<b>SafeTec T2-1000DC-3+0</b>		<b>1000</b>
Weight	pounds	.853
	grams	387
<b>SafeTec T2-1000DC-3+0-R</b>		
Weight	pounds	.870
	grams	395
DIN 43880 Dimension		3 TE / 2.13" [54]
Packaging Dimensions (HxWxL)		4.3 x 4.5 x 13.8" [109 x 115 x 352 mm]
Standard Order Quantity		5 Units

### Plug Internal Configuration

#### SafeTec T2-xxxxDC-P

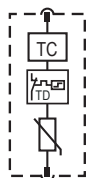

#### SafeTube T2-DC-P

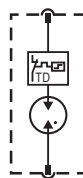

inches  
[mm]

Information contained in this document is subject to change at any time without notice.

