

ProTec T1S 1+0

Class I • Class II • Type 1 • Type 2



Location of Use: Main Distribution Boards
 Network Systems: TN-S, TN-C, TT (only L-N)
 Mode of Protection: L-PE, N-PE (only TN-S), L-PEN, L-N
 IEC/EN Category: Class I+II / Type 1+2
 Housing: Pluggable Design
 Compliance: IEC 61643-11:2011
 EN 61643-11:2012

Technical Data

ProTec T1S-xxx-1+0(-R)

275

IEC Electrical

Nominal AC Voltage (50/60Hz)	U_o/U_n	240V
Maximum Continuous Operating Voltage (AC)	U_c	275V
Nominal Discharge Current (8/20 μ s)	I_n	25kA
Maximum Discharge Current (8/20 μ s)	I_{max}	65kA
Impulse Discharge Current (10/350 μ s)	I_{imp}	25kA
Specific Energy	W/R	156.2 kJ/ Ω
Charge	Q	12.5 As
Voltage Protection Level	U_p	1500V
Response Time	t_A	< 100ns
Overcurrent Protection (max)		315 A gG
Short-Circuit Current Rating (AC)	I_{SCCR}	50kA
Follow Current Interrupt Rating	I_{fi}	50 kA _{RMS}
TOV Withstand 120min	U_T	442V
Number of Ports		1

Mechanical & Environmental

Operating Temperature Range	T_a	-40 °F to +185 °F [-40 °C to +85 °C]
Permissible Operating Humidity	RH	5%...95%
Altitude		6562 ft [2000m]
Terminal Screw Torque	M_{max}	39.9 lbf-in [4.5Nm]
Conductor Cross Section (max)		2 AWG (Solid, Stranded) / 4 AWG (Flexible) 35 mm ² (Solid, Stranded) / 25 mm ² (Flexible)
Mounting		35 mm DIN Rail, EN 60715
Degree of Protection		IP 20 (built-in)
Housing Material		Thermoplastic: Extinguishing Degree UL 94 V-0
Thermal Protection		Yes
Operating State / Fault Indication		Green Flag / Not Green Flag
Remote Contacts (RC)		Optional
RC Switching Capacity		AC: 250V/1A, 125V/1 A; DC: 48V/0.5A, 24V/0.5A, 12V/0.5 A
RC Conductor Cross Section (max)		16 AWG (Solid) / 1.5 mm ² (Solid)

Order Information

Order Code	275
ProTec T1S-xxx-1+0	59.0738
ProTec T1S-xxx-1+0-R (with remote contacts)	59.0739
ProTec T1S-xxx-P (plug)	59.0384

Internal Configuration

Legend

- L Line Conductor Terminal
- N Neutral Conductor Terminal
- ⊥ PE/G Conductor Terminal
- RC Remote Contacts Terminal (Optional)
- TD Thermal Disconnecter

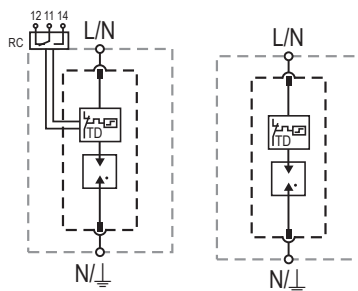

Complete Unit

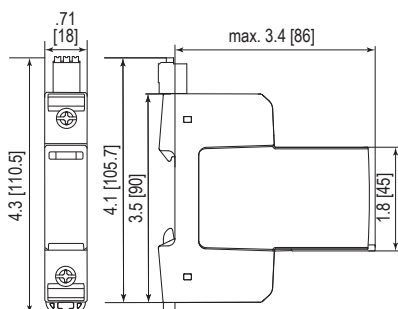

Dimensions & Packaging

ProTec T1S-xxx-1+0	
Single Unit Weight pounds [grams]	.381 [173]
ProTec T1S-xxx-1+0-R	
Single Unit Weight pounds [grams]	.396 [180]
Single Unit DIN 43880 Dimension	1 TE / .71 [18]
Packaging Dimensions (HxWxL)	4.3 x 4.5 x 13.8" [109 x 115 x 352 mm]
Standard Order Quantity	12 Units

Plug Internal Configuration

ProTec T1S-xxx-P

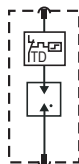

Spare Plug

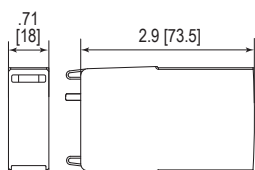

Dimensions & Packaging

ProTec T1S-xxx-P	
Single Unit Weight pounds [grams]	.231 [105]
Single Unit DIN 43880 Dimension	1 TE / .71 [18]
Packaging Dimensions (HxWxL)	4.3 x 4.5 x 13.8" [109 x 115 x 352 mm]
Standard Order Quantity	28 Units

inches
[mm]

Information contained in this document is subject to change at any time without notice.



ProTec T1S 2+0

Class I • Class II • Type 1 • Type 2



Location of Use: Main Distribution Boards
 Network Systems: TN-S
 Mode of Protection: L-PE, N-PE
 IEC/EN Category: Class I+II / Type 1+2
 Housing: Pluggable Design
 Compliance: IEC 61643-11:2011
 EN 61643-11:2012

Technical Data

ProTec T1S-xxx-2+0(-R)

275

IEC Electrical

Nominal AC Voltage (50/60Hz)	U_o/U_n	240V
Maximum Continuous Operating Voltage (AC)	U_c	275V
Nominal Discharge Current (8/20 μ s)	I_n	25kA
Maximum Discharge Current (8/20 μ s)	I_{max}	65kA
Impulse Discharge Current (10/350 μ s)	I_{imp}	25kA
Specific Energy	W/R	156.2 kJ/ Ω
Charge	Q	12.5 As
Voltage Protection Level	U_p	1500V
Response Time	t_A	< 100ns
Overcurrent Protection (max)		315 A gG
Short-Circuit Current Rating (AC)	I_{SCCR}	50kA
Follow Current Interrupt Rating	I_{fi}	50 kA _{RMS}
TOV Withstand 120min	U_T	442V
Number of Ports		1

Mechanical & Environmental

Operating Temperature Range	T_a	-40 °F to +185 °F [-40 °C to +85 °C]
Permissible Operating Humidity	RH	5%...95%
Altitude		6562 ft [2000m]
Terminal Screw Torque	M_{max}	39.9 lbf-in [4.5Nm]
Conductor Cross Section (max)		2 AWG (Solid, Stranded) / 4 AWG (Flexible) 35 mm ² (Solid, Stranded) / 25 mm ² (Flexible)
Mounting		35 mm DIN Rail, EN 60715
Degree of Protection		IP 20 (built-in)
Housing Material		Thermoplastic: Extinguishing Degree UL 94 V-0
Thermal Protection		Yes
Operating State / Fault Indication		Green Flag / Not Green Flag
Remote Contacts (RC)		Optional
RC Switching Capacity		AC: 250V/1A, 125V/1 A; DC: 48V/0.5A, 24V/0.5A, 12V/0.5 A
RC Conductor Cross Section (max)		16 AWG (Solid) / 1.5 mm ² (Solid)

Order Information

Order Code	275
ProTec T1S-xxx-2+0	59.0740
ProTec T1S-xxx-2+0-R (with remote contacts)	59.0741
ProTec T1S-xxx-P (plug)	59.0384

Internal Configuration

Legend

- L Line Conductor Terminal
- N Neutral Conductor Terminal
- ⏚ PE/G Conductor Terminal
- RC Remote Contacts Terminal (Optional)
- TD Thermal Disconnect

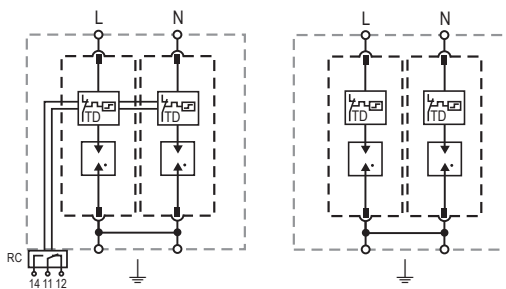

Complete Unit

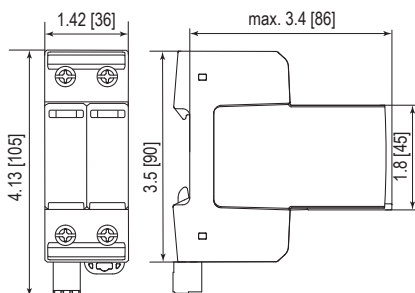

Dimensions & Packaging

ProTec T1S-xxx-2+0	275
Single Unit Weight pounds [grams]	.749 [340]
ProTec T1S-xxx-2+0-R	275
Single Unit Weight pounds [grams]	.769 [349]
Single Unit DIN 43880 Dimension	2 TE / 1.42 [36]
Packaging Dimensions (HxWxL)	4.3 x 4.5 x 13.8" [109 x 115 x 352 mm]
Standard Order Quantity	7 Units

Plug Internal Configuration

ProTec T1S-xxx-P

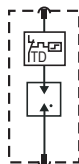

Spare Plug

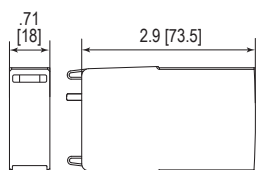

Dimensions & Packaging

ProTec T1S-xxx-P	275
Single Unit Weight pounds [grams]	.231 [105]
Single Unit DIN 43880 Dimension	1 TE / .71 [18]
Packaging Dimensions (HxWxL)	4.3 x 4.5 x 13.8" [109 x 115 x 352 mm]
Standard Order Quantity	28 Units

inches
[mm]

Information contained in this document is subject to change at any time without notice.



Lightning and Overvoltage Protection
ProTec T1S 3+0
 Class I • Class II • Type 1 • Type 2



Location of Use: Main Distribution Boards
 Network Systems: TN-C
 Mode of Protection: L-PEN
 IEC/EN Category: Class I+II / Type 1+2
 Housing: Pluggable Design
 Compliance: IEC 61643-11:2011
 EN 61643-11:2012

Technical Data

ProTec T1S-xxx-3+0(-R)

275

IEC Electrical

Nominal AC Voltage (50/60Hz)	U_o/U_n	240V
Maximum Continuous Operating Voltage (AC)	U_c	275V
Nominal Discharge Current (8/20 μ s)	I_n	25 kA
Maximum Discharge Current (8/20 μ s)	I_{max}	65 kA
Impulse Discharge Current (10/350 μ s)	I_{imp}	25 kA
Specific Energy	W/R	156.2 kJ/ Ω
Charge	Q	12.5 As
Voltage Protection Level	U_p	1500V
Response Time	t_A	< 100ns
Overcurrent Protection (max)		315 A gG
Short-Circuit Current Rating (AC)	I_{SCCR}	50 kA
Follow Current Interrupt Rating	I_{fi}	50 kA _{RMS}
TOV Withstand 120min	U_T	442V
Number of Ports		1

Mechanical & Environmental

Operating Temperature Range	T_a	-40 °F to +185 °F [-40 °C to +85 °C]
Permissible Operating Humidity	RH	5%...95%
Altitude		6562 ft [2000m]
Terminal Screw Torque	M_{max}	39.9 lbf-in [4.5Nm]
Conductor Cross Section (max)		2 AWG (Solid, Stranded) / 4 AWG (Flexible) 35 mm ² (Solid, Stranded) / 25 mm ² (Flexible)
Mounting		35 mm DIN Rail, EN 60715
Degree of Protection		IP 20 (built-in)
Housing Material		Thermoplastic: Extinguishing Degree UL 94 V-0
Thermal Protection		Yes
Operating State / Fault Indication		Green Flag / Not Green Flag
Remote Contacts (RC)		Optional
RC Switching Capacity		AC: 250V/1A, 125V/1 A; DC: 48V/0.5A, 24V/0.5A, 12V/0.5 A
RC Conductor Cross Section (max)		16 AWG (Solid) / 1.5 mm ² (Solid)

Order Information

Order Code	275
ProTec T1S-xxx-3+0	59.0742
ProTec T1S-xxx-3+0-R (with remote contacts)	59.0743
ProTec T1S-xxx-P (plug)	59.0384

Internal Configuration

Legend

- L Line Conductor Terminal
- ⏏ PE/G Conductor Terminal
- RC Remote Contacts Terminal (Optional)
- TD Thermal Disconnect

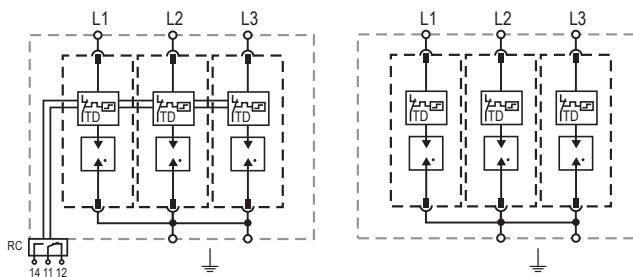

Complete Unit

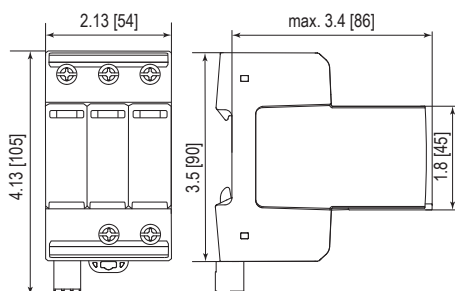

Dimensions & Packaging

ProTec T1S-xxx-3+0	275
Single Unit Weight pounds [grams]	1.100 [499]
ProTec T1S-xxx-3+0-R	275
Single Unit Weight pounds [grams]	1.119 [508]
Single Unit DIN 43880 Dimension	3TE / 2.13 [54]
Packaging Dimensions (HxWxL)	4.3 x 4.5 x 13.8" [109 x 115 x 352 mm]
Standard Order Quantity	5 Units

Plug Internal Configuration

ProTec T1S-xxx-P

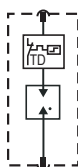

Spare Plug

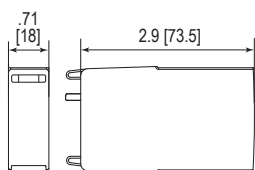

Dimensions & Packaging

ProTec T1S-xxx-P	275
Single Unit Weight pounds [grams]	.231 [105]
Single Unit DIN 43880 Dimension	1 TE / .71 [18]
Packaging Dimensions (HxWxL)	4.3 x 4.5 x 13.8" [109 x 115 x 352 mm]
Standard Order Quantity	28 Units

inches
[mm]

Information contained in this document is subject to change at any time without notice.



Lightning and Overvoltage Protection
ProTec T1S 4+0
 Class I • Class II • Type 1 • Type 2



Location of Use: Main Distribution Boards
 Network Systems: TN-S
 Mode of Protection: L-PE, N-PE
 IEC/EN Category: Class I+II / Type 1+2
 Housing: Pluggable Design
 Compliance: IEC 61643-11:2011
 EN 61643-11:2012

Technical Data

ProTec T1S-xxx-4+0(-R)

275

IEC Electrical

Nominal AC Voltage (50/60Hz)	U_o/U_n	240V
Maximum Continuous Operating Voltage (AC)	U_c	275V
Nominal Discharge Current (8/20 μ s)	I_n	25 kA
Maximum Discharge Current (8/20 μ s)	I_{max}	65 kA
Impulse Discharge Current (10/350 μ s)	I_{imp}	25 kA
Specific Energy	W/R	156.2 kJ/ Ω
Charge	Q	12.5 As
Voltage Protection Level	U_p	1500V
Response Time	t_A	< 100ns
Overcurrent Protection (max)		315 A gG
Short-Circuit Current Rating (AC)	I_{SCCR}	50 kA
Follow Current Interrupt Rating	I_{fi}	50 kA _{RMS}
TOV Withstand 120min	U_T	442V
Number of Ports		1

Mechanical & Environmental

Operating Temperature Range	T_a	-40 °F to +185 °F [-40 °C to +85 °C]
Permissible Operating Humidity	RH	5%...95%
Altitude		6562 ft [2000m]
Terminal Screw Torque	M_{max}	39.9 lbf-in [4.5Nm]
Conductor Cross Section (max)		2 AWG (Solid, Stranded) / 4 AWG (Flexible) 35 mm ² (Solid, Stranded) / 25 mm ² (Flexible)
Mounting		35 mm DIN Rail, EN 60715
Degree of Protection		IP 20 (built-in)
Housing Material		Thermoplastic: Extinguishing Degree UL 94 V-0
Thermal Protection		Yes
Operating State / Fault Indication		Green Flag / Not Green Flag
Remote Contacts (RC)		Optional
RC Switching Capacity		AC: 250V/1A, 125V/1 A; DC: 48V/0.5A, 24V/0.5A, 12V/0.5 A
RC Conductor Cross Section (max)		16 AWG (Solid) / 1.5 mm ² (Solid)

Order Information

Order Code	275
ProTec T1S-xxx-4+0	59.0744
ProTec T1S-xxx-4+0-R (with remote contacts)	59.0745
ProTec T1S-xxx-P (plug)	59.0384

Internal Configuration

Legend

- L Line Conductor Terminal
- N Neutral Conductor Terminal
- PE/G Conductor Terminal
- RC Remote Contacts Terminal (Optional)
- TD Thermal Disconnect

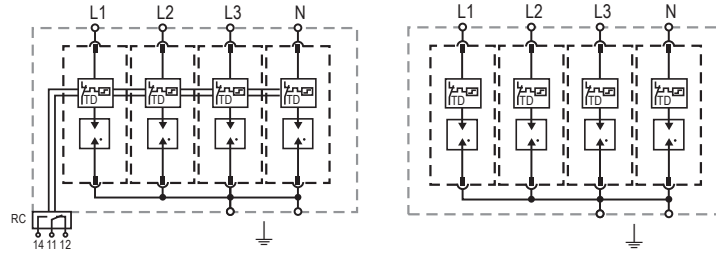

Complete Unit

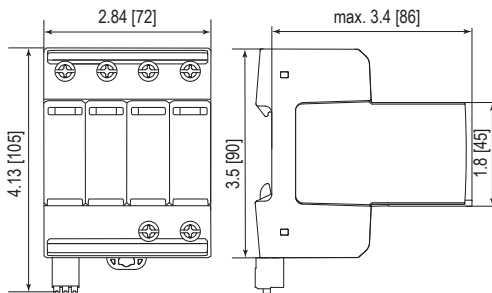

Dimensions & Packaging

ProTec T1S-xxx-4+0	275
Single Unit Weight pounds [grams]	1.481 [672]
ProTec T1S-xxx-4+0-R	275
Single Unit Weight pounds [grams]	1.501 [681]
Single Unit DIN 43880 Dimension	4 TE / 2.84 [72]
Packaging Dimensions (HxWxL)	4.3 x 4.5 x 13.8" [109 x 115 x 352 mm]
Standard Order Quantity	4 Units

Plug Internal Configuration

ProTec T1S-xxx-P

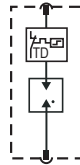

Spare Plug

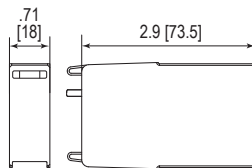

Dimensions & Packaging

ProTec T1S-xxx-P	275
Single Unit Weight pounds [grams]	.231 [105]
Single Unit DIN 43880 Dimension	1 TE / .71 [18]
Packaging Dimensions (HxWxL)	4.3 x 4.5 x 13.8" [109 x 115 x 352 mm]
Standard Order Quantity	28 Units

inches
[mm]

Information contained in this document is subject to change at any time without notice.



ProTec T1S 1+1

Class I • Class II • Type 1 • Type 2



Location of Use: Main Distribution Boards
 Network Systems: TT, TN-S
 Mode of Protection: L-N, N-PE
 IEC/EN Category: Class I+II / Type 1+2
 Housing: Pluggable Design
 Compliance: IEC 61643-11:2011
 EN 61643-11:2012

Technical Data

ProTec T1S-xxx-1+1(-R)

275

IEC Electrical

Nominal AC Voltage (50/60Hz)	U_o/U_n	240V
Maximum Continuous Operating Voltage (AC)	(L-N) / (N-PE) U_c	275V / 305V
Nominal Discharge Current (8/20 μ s)	(L-N) / (N-PE) I_n	25kA / 100kA
Maximum Discharge Current (8/20 μ s)	(L-N) / (N-PE) I_{max}	65kA / 150kA
Impulse Discharge Current (10/350 μ s)	(L-N) / (N-PE) I_{imp}	25kA / 100kA
Specific Energy	(L-N) / (N-PE) W/R	156.2kJ/ Ω / 2500 kJ/ Ω
Charge	(L-N) / (N-PE) Q	12.5As / 50As
Voltage Protection Level	(L-N) / (N-PE) U_p	1500V / 1500V
Response Time	(L-N) / (N-PE) t_A	< 100ns / < 100ns
Overcurrent Protection (max)		315A gG
Short-Circuit Current Rating (AC)	(L-N) I_{SCCR}	50kA
Follow Current Interrupt Rating	(L-N) / (N-PE) I_{fi}	50kA _{RMS} / 100A _{RMS}
TOV Withstand 120min	(L-N) U_T	442V
TOV Withstand 200ms	(N-PE) U_T	1200V
Number of Ports		1

Mechanical & Environmental

Operating Temperature Range	T_a	-40 °F to +185 °F [-40 °C to +85 °C]
Permissible Operating Humidity	RH	5%...95%
Altitude		6562 ft [2000m]
Terminal Screw Torque	M_{max}	39.9 lbf-in [4.5Nm]
Conductor Cross Section (max)		2 AWG (Solid, Stranded) / 4 AWG (Flexible) 35 mm ² (Solid, Stranded) / 25 mm ² (Flexible)
Mounting		35 mm DIN Rail, EN 60715
Degree of Protection		IP 20 (built-in)
Housing Material		Thermoplastic: Extinguishing Degree UL 94 V-0
Thermal Protection		Yes
Operating State / Fault Indication		Green Flag / Not Green Flag
Remote Contacts (RC)		Optional
RC Switching Capacity		AC: 250V/1A, 125V/1 A; DC: 48V/0.5A, 24V/0.5A, 12V/0.5A
RC Conductor Cross Section (max)		16 AWG (Solid) / 1.5 mm ² (Solid)

Order Information

Order Code	275
ProTec T1S-xxx-1+1	59.0746
ProTec T1S-xxx-1+1-R (with remote contacts)	59.0747
ProTec T1S-xxx-P (plug L-N)	59.0384
ProTube T1S-100-P (plug N-PE)	59.0386

Internal Configuration

Legend

- L Line Conductor Terminal
- N Neutral Conductor Terminal
- PE/G Conductor Terminal
- RC Remote Contacts Terminal (Optional)
- TD Thermal Disconnect
- TI Thermal Indication

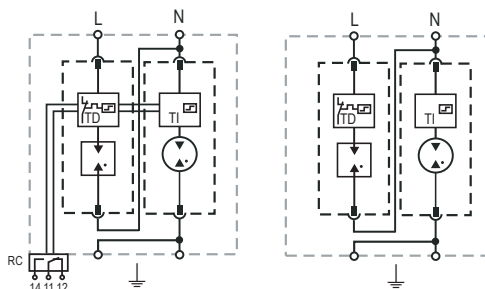

Complete Unit

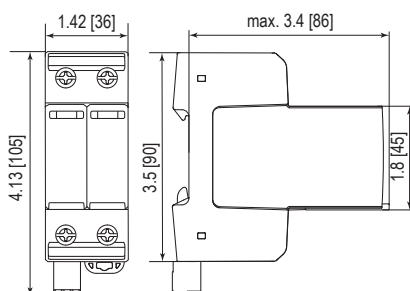

Dimensions & Packaging

ProTec T1S-xxx-1+1	275
Single Unit Weight pounds [grams]	.773 [351]
ProTec T1S-xxx-1+1-R	275
Single Unit Weight pounds [grams]	.787 [357]
Single Unit DIN 43880 Dimension	2 TE / 1.42 [36]
Packaging Dimensions (HxWxL)	4.3 x 4.5 x 13.8" [109 x 115 x 352 mm]
Standard Order Quantity	7 Units

Plug Internal Configuration

ProTec T1S-xxx-P

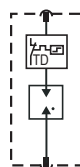

ProTube T1S-100-P

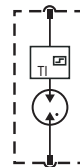

Spare Plug

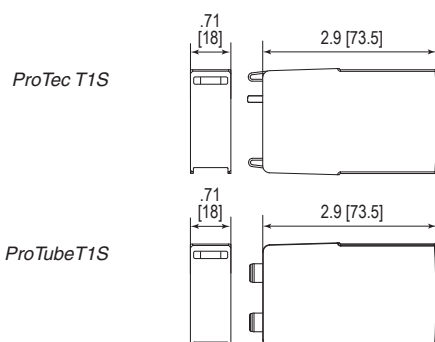

Dimensions & Packaging

ProTec T1S-xxx-P	275
Single Unit Weight pounds [grams]	.231 [105]
ProTube T1S-100-P	100
Single Unit Weight pounds [grams]	.253 [115]
Single Unit DIN 43880 Dimension	1 TE / .71 [18]
Packaging Dimensions (HxWxL)	4.3 x 4.5 x 13.8" [109 x 115 x 352 mm]
Standard Order Quantity	28 Units

inches
[mm]

Information contained in this document is subject to change at any time without notice.



Lightning and Overvoltage Protection
ProTec T1S 3+1
 Class I • Class II • Type 1 • Type 2



Location of Use: Main Distribution Boards
 Network Systems: TT, TN-S
 Mode of Protection: L-N, N-PE
 IEC/EN Category: Class I+II / Type 1+2
 Housing: Pluggable Design
 Compliance: IEC 61643-11:2011
 EN 61643-11:2012

Technical Data

ProTec T1S-xxx-3+1(-R)

275

IEC Electrical

Nominal AC Voltage (50/60Hz)	U_o/U_n	240V
Maximum Continuous Operating Voltage (AC)	(L-N) / (N-PE) U_c	275V / 305V
Nominal Discharge Current (8/20 μ s)	(L-N) / (N-PE) I_n	25kA / 100kA
Maximum Discharge Current (8/20 μ s)	(L-N) / (N-PE) I_{max}	65kA / 150kA
Impulse Discharge Current (10/350 μ s)	(L-N) / (N-PE) I_{imp}	25kA / 100kA
Specific Energy	(L-N) / (N-PE) W/R	156.2kJ/ Ω / 2500 kJ/ Ω
Charge	(L-N) / (N-PE) Q	12.5As / 50As
Voltage Protection Level	(L-N) / (N-PE) U_p	1500V / 1500V
Response Time	(L-N) / (N-PE) t_A	< 100ns / < 100ns
Overcurrent Protection (max)		315A gG
Short-Circuit Current Rating (AC)	(L-N) I_{SCCR}	50kA
Follow Current Interrupt Rating	(L-N) / (N-PE) I_{fi}	50kA _{RMS} / 100A _{RMS}
TOV Withstand 120min	(L-N) U_T	442V
TOV Withstand 200ms	(N-PE) U_T	1200V
Number of Ports		1

Mechanical & Environmental

Operating Temperature Range	T_a	-40 °F to +185 °F [-40 °C to +85 °C]
Permissible Operating Humidity	RH	5%...95%
Altitude		6562 ft [2000m]
Terminal Screw Torque	M_{max}	39.9 lbf-in [4.5Nm]
Conductor Cross Section (max)		2 AWG (Solid, Stranded) / 4 AWG (Flexible) 35 mm ² (Solid, Stranded) / 25 mm ² (Flexible)
Mounting		35 mm DIN Rail, EN 60715
Degree of Protection		IP 20 (built-in)
Housing Material		Thermoplastic: Extinguishing Degree UL 94 V-0
Thermal Protection		Yes
Operating State / Fault Indication		Green Flag / Not Green Flag
Remote Contacts (RC)		Optional
RC Switching Capacity		AC: 250V/1A, 125V/1 A; DC: 48V/0.5A, 24V/0.5A, 12V/0.5A
RC Conductor Cross Section (max)		16 AWG (Solid) / 1.5 mm ² (Solid)

Order Information

Order Code	275
ProTec T1S-xxx-3+1	59.0748
ProTec T1S-xxx-3+1-R (with remote contacts)	59.0749
ProTec T1S-xxx-P (plug L-N)	59.0384
ProTube T1S-100-P (plug N-PE)	59.0386

Internal Configuration

Legend

- L Line Conductor Terminal
- N Neutral Conductor Terminal
- PE/G Conductor Terminal
- RC Remote Contacts Terminal (Optional)
- TD Thermal Disconnect
- TI Thermal Indication

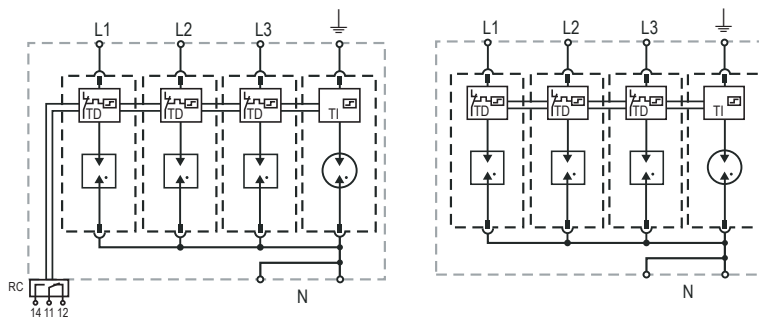

Complete Unit

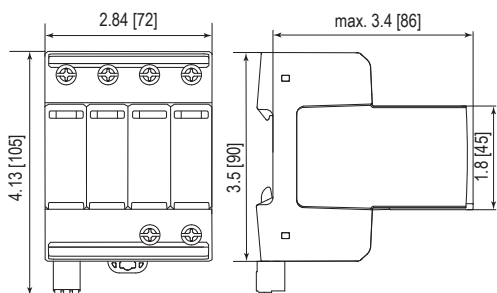

Dimensions & Packaging

ProTec T1S-xxx-3+1	275
Single Unit Weight pounds [grams]	1.503 [682]
ProTec T1S-xxx-3+1-R	275
Single Unit Weight pounds [grams]	1.523 [691]
Single Unit DIN 43880 Dimension	4 TE / 2.84 [72]
Packaging Dimensions (HxWxL)	4.3 x 4.5 x 13.8" [109 x 115 x 352 mm]
Standard Order Quantity	4 Units

Plug Internal Configuration

Legend

- TD Thermal Disconnect
- TI Thermal Indication

ProTec T1S-xxx-P

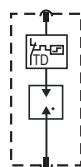

ProTube T1S-100-P

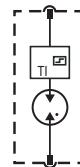

Spare Plug

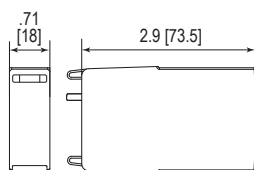

Dimensions & Packaging

ProTec T1S-xxx-P	275
Single Unit Weight pounds [grams]	.231 [105]
ProTube T1S-100-P	100
Single Unit Weight pounds [grams]	.253 [115]
Single Unit DIN 43880 Dimension	1 TE / .71 [18]
Packaging Dimensions (HxWxL)	4.3 x 4.5 x 13.8" [109 x 115 x 352 mm]
Standard Order Quantity	28 Units

inches
[mm]

Information contained in this document is subject to change at any time without notice.



ProTec T1S 3+1 N

Class I • Class II • Type 1 • Type 2



Location of Use: Main Distribution Boards
 Network Systems: TT, TN-S
 Mode of Protection: L-N, N-PE
 IEC/EN Category: Class I+II / Type 1+2
 Housing: Pluggable Design
 Compliance: IEC 61643-11:2011
 EN 61643-11:2012

Technical Data

ProTec T1S-xxx-3+1-N(-R)

275

IEC Electrical

Nominal AC Voltage (50/60Hz)	U_o/U_n	240V
Maximum Continuous Operating Voltage (AC)	(L-N) / (N-PE) U_c	275V / 305V
Nominal Discharge Current (8/20 μ s)	(L-N) / (N-PE) I_n	25kA / 100kA
Maximum Discharge Current (8/20 μ s)	(L-N) / (N-PE) I_{max}	65kA / 150kA
Impulse Discharge Current (10/350 μ s)	(L-N) / (N-PE) I_{imp}	25kA / 100kA
Specific Energy	(L-N) / (N-PE) W/R	156.2kJ/ Ω / 2500 kJ/ Ω
Charge	(L-N) / (N-PE) Q	12.5As / 50As
Voltage Protection Level	(L-N) / (N-PE) U_p	1700V / 1500V
Response Time	(L-N) / (N-PE) t_A	< 100ns / < 100ns
Overcurrent Protection (max)		315A gG
Short-Circuit Current Rating (AC)	(L-N) I_{SCCR}	50kA
Follow Current Interrupt Rating	(L-N) / (N-PE) I_{fi}	50kA _{RMS} / 100A _{RMS}
TOV Withstand 120min	(L-N) U_T	442V
TOV Withstand 200ms	(N-PE) U_T	1200V
Number of Ports		1

Mechanical & Environmental

Operating Temperature Range	T_a	-40 °F to +185 °F [-40 °C to +85 °C]
Permissible Operating Humidity	RH	5%...95%
Altitude		6562 ft [2000m]
Terminal Screw Torque	M_{max}	39.9 lbf-in [4.5Nm]
Conductor Cross Section (max)		2 AWG (Solid, Stranded) / 4 AWG (Flexible) 35 mm ² (Solid, Stranded) / 25 mm ² (Flexible)
Mounting		35 mm DIN Rail, EN 60715
Degree of Protection		IP 20 (built-in)
Housing Material		Thermoplastic: Extinguishing Degree UL 94 V-0
Thermal Protection		Yes
Operating State / Fault Indication		Green Flag / Not Green Flag
Remote Contacts (RC)		Optional
RC Switching Capacity		AC: 250V/1A, 125V/1 A; DC: 48V/0.5A, 24V/0.5A, 12V/0.5 A
RC Conductor Cross Section (max)		16 AWG (Solid) / 1.5 mm ² (Solid)

Order Information

Order Code	275
ProTec T1S-xxx-3+1-N	59.0382
ProTec T1S-xxx-3+1-N-R (with remote contacts)	59.0383
ProTec T1S-xxx-N-P (plug L-N)	59.0385
ProTube T1S-100-P (plug N-PE)	59.0386

Internal Configuration

Legend

- L Line Conductor Terminal
- N Neutral Conductor Terminal
- PE/G Conductor Terminal
- RC Remote Contacts Terminal (Optional)
- TD Thermal Disconnect
- TI Thermal Indication

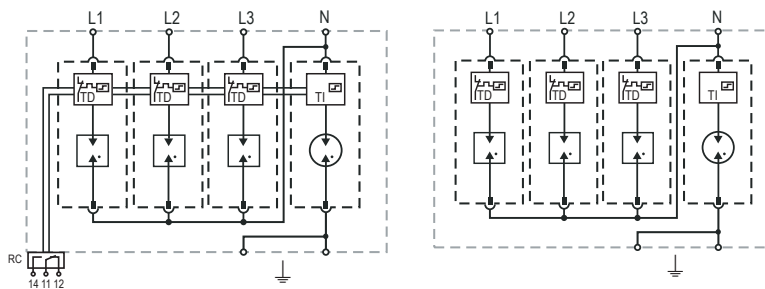

Complete Unit

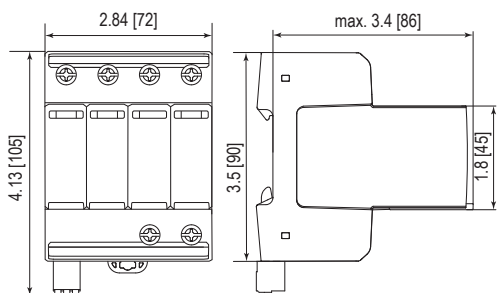

Dimensions & Packaging

ProTec T1S-xxx-3+1-N	275
Single Unit Weight pounds [grams]	1.503 [682]
ProTec T1S-xxx-3+1-N-R	275
Single Unit Weight pounds [grams]	1.523 [691]
Single Unit DIN 43880 Dimension	4 TE / 2.84 [72]
Packaging Dimensions (HxWxL)	4.3 x 4.5 x 13.8" [109 x 115 x 352 mm]
Standard Order Quantity	4 Units

Plug Internal Configuration

ProTec T1S-xxx-N-P

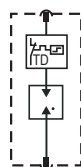

ProTube T1S-100-P

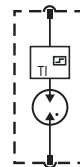

Spare Plug

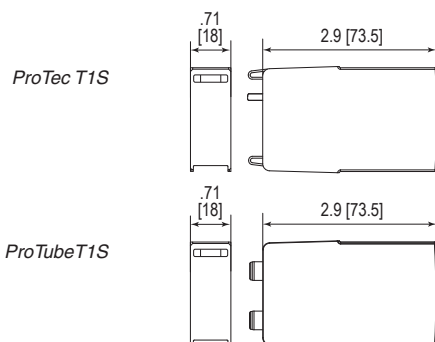

Dimensions & Packaging

ProTec T1S-xxx-N-P	275
Single Unit Weight pounds [grams]	.231 [105]
ProTube T1S-100-P	100
Single Unit Weight pounds [grams]	.253 [115]
Single Unit DIN 43880 Dimension	1 TE / .71 [18]
Packaging Dimensions (HxWxL)	4.3 x 4.5 x 13.8" [109 x 115 x 352 mm]
Standard Order Quantity	28 Units

inches
[mm]

Information contained in this document is subject to change at any time without notice.

