



www.raycap.com

Information contained in this document is subject to change at any time without notice.



### Installation Instructions Installationsanleitung Manuel d'installation Instrucciones de Instalación Istruzioni per l'installazione

	1 MPPT [3Y]	TYPE 1	a ProTec T1-1100PV-3Y-Box	515 608
			b ProTec T1-1500PV-3Y-S-Box	515 612
	2 MPPT [5Y]	TYPE 2	c ProTec T2-1100PV-3Y-L-Box	515 546
			d ProTec T2-1500PV-3Y-L-Box	515 548
		TYPE 1	a ProTec T1-1100PV-5Y-Box	515 609
			b ProTec T1-1500PV-5Y-S-Box	515 613
		TYPE 2	c ProTec T2-1100PV-5Y-L-Box	515 545
			d ProTec T2-1500PV-5Y-L-Box	515 547

#### ENGLISH

Please read the following before installing your Surge Protective Device:

- Verify the system voltage and configuration on the label if it is appropriate for the application.
- Risk of Electric Shock – Installation and maintenance should be performed by qualified personnel only.
- Disconnect from energized circuits before installing or servicing.
- Safety rules and regulations applicable to all devices connected to power lines should always be followed. National standards and safety regulations must be followed.
- The external mechanical integrity of the device must be checked before installation. Products with visible damage should not be installed.
- Its use is only permitted within the limits shown and stated in these installation instructions. Opening or tampering with the device invalidates the warranty.
- Connecting leads shall be kept as short as possible, without loops.

#### DEUTSCH

Bitte lesen Sie die folgenden Angaben vor Installation der Überspannungsschutzgerät:

- Sicherstellen, dass die Systemspannung und -konfiguration auf dem Etikett für die Anwendung geeignet ist.
- Stromschlaggefahr – Installation und Wartung sollten nur vom Fachmann durchgeführt werden.
- Gerät vor der Installation oder Wartung/Reparatur von spannungsführenden Leitungen trennen.
- Die Sicherheitsvorschriften und -regeln für alle an Stromleitungen angeschlossenen Geräte sind stets zu befolgen. Vor Ort geltende Normen und Sicherheitsvorschriften befolgen.
- Vor der Installation ist die externe mechanische Unversehrtheit des Geräts sicherzustellen. Produkte mit sichtbaren Schäden dürfen nicht installiert werden.
- Das Gerät ist nur für den Betrieb innerhalb der angegebenen Grenzwerte zugelassen. Wird das Gerät geöffnet oder manipuliert, erlischt die Garantie.
- Anschlussleitungen sollten so kurz wie möglich gehalten werden, dürfen keine Schleifen enthalten.

#### FRANÇAIS

Veillez lire les instructions suivantes avant d'installer votre parafoudre:

- Vérifiez que la tension et la configuration du système sur l'étiquette du produit convient à l'application
- Déconnectez le produit de circuits sous tension avant l'installation ou l'entretien
- Les règles de sécurité et les réglementations applicables aux appareils connectés aux lignes électriques doivent toujours être respectées. Les normes nationales et les règles de sécurité doivent être respectées
- L'intégrité mécanique externe du produit doit être vérifiée avant l'installation. Les produits présentant des dommages visibles ne doivent pas être installés
- L'utilisation du produit est uniquement autorisée dans les limites indiquées dans ce manuel d'installation. Le désassemblage ou la modification du produit annule sa garantie
- Les câbles de raccordement doivent être aussi courts que possible, sans boucle.

#### ESPAÑOL

Lea las siguientes instrucciones antes de la instalación de su dispositivo de protección contra sobretensiones:

- Compruebe que la tensión y configuración del sistema que aparecen en la etiqueta son adecuadas para su instalación.
- Riesgo de descarga eléctrica: únicamente personal cualificado puede instalar o dar mantenimiento a este dispositivo.
- Desconecte los circuitos con tensión antes instalarlo o darle mantenimiento.
- Siga siempre todas las normativas y reglamentos de seguridad pertinentes a todos los dispositivos conectados a la red eléctrica. Debe respetar la normativa nacional y los reglamentos de seguridad.
- Compruebe la integridad mecánica externa del dispositivo antes de su instalación. Nunca instale productos que presenten daños visibles.
- Sólo se permite utilizarse dentro de los límites establecidos en estas instrucciones de instalación. Abrir o alterar el dispositivo anula la garantía.
- Las conexiones de cables deben ser lo más cortas posibles, sin bucles.

#### ITALIANO

Prima di installare il limitatore di sovratensione (SPD: Surge Protective Device), leggere attentamente quanto segue:

- Verificare la tensione e la configurazione del sistema sull'etichetta per capire se sono appropriati per l'applicazione del dispositivo.
- Rischi di elettrocuzione – L'installazione e la manutenzione devono essere effettuate unicamente da personale qualificato.
- Togliere corrente ai circuiti, prima dell'installazione o della manutenzione.
- È necessario rispettare sempre le normative e i regolamenti di sicurezza applicabili, per tutti i dispositivi collegati alla linea elettrica. È necessario rispettare gli standard nazionali e i regolamenti di sicurezza.
- Prima dell'installazione, è necessario verificare l'integrità meccanica esterna del dispositivo. Non bisogna installare prodotti che mostrino danni evidenti.
- Il suo uso è consentito solo entro i limiti indicati e dichiarati in queste istruzioni di installazione. L'apertura o la manomissione del dispositivo causano l'annullamento della garanzia.
- L'interconnessione delle parti conduttrici deve essere la più corta possibile, evitando la formazione di anelli.

TECHNICAL DATA	ProTec 3Y(-S)(-L)-Box ProTec 5Y(-S)(-L)-Box		<b>a</b>	<b>b</b>	<b>c</b>	<b>d</b>
			Type 1 1100V	Type 1 1500V	Type 2 1100V	Type 2 1500V
$U_{CPV}$	DC	1100 V	1500 V	1100 V	1500 V	
$I_n$ (8/20)		20 kA	20 kA	20 kA	15 kA	
$I_{max}$ (8/20)		40 kA	50 kA	40 kA	40 kA	
$I_{imp}$ (10/350)		6.25 kA	6.25 kA	-	-	
$I_{Total}$ (8/20) / $I_{Total}$ (10/350)		50 kA / 12.5 kA	50 kA / 12.5 kA	40 kA / -	40 kA / -	
$U_p$		4400 V	5200 V	4200 V	4800 V	
$I_{scpv}$		11 kA	30 kA	9 kA	9 kA	
$I_{PE}$	AC/DC	< 1 mA / < 50 $\mu$ A	< 2.5 mA / < 100 $\mu$ A	< 1 mA / < 50 $\mu$ A	< 1 mA / < 50 $\mu$ A	
$I_{cpv}$	DC	< 50 $\mu$ A	< 100 $\mu$ A	< 50 $\mu$ A	< 50 $\mu$ A	
SPD Failure Mode		Open Circuit Failure Mode (OCFM)				
Type of PV System		Not earthed/earthed				
Number of Strings per MPPT		1 [3Y]		2 [5Y]		
$T_a$		-40°C to +85°C [-40°F to +185°F]				
RH		5%...95%				
Mounting		Outdoor wall				
Altitude (max)		4000 m [13123 ft]				
IP		67				

per IEC/EN 61643-31

Mecha. & Envi.

**INSTALLATION**



**WARNING!**  
Before the first use of the PV Box, modules shall be firmly pressed into the PCB, as connecting on a dislocated SPD module can result in non-functional surge protection.

**NOTE:**  
ProTec T1-1500PV-xY-S-Box  
middle module is without indication.

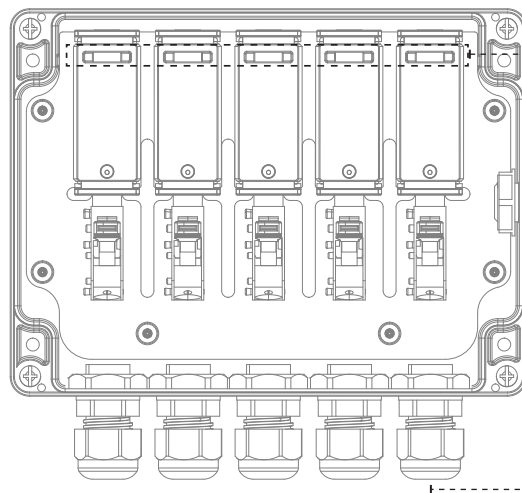

**Fault Indication**

- Green / Grün
- Not Green / Nicht grün
- ↓
- Replace PV Box  
Ersetzen PV Box

**Wire insulation outer diameter:**  
min  $\phi$  4 mm  
max  $\phi$  8 mm

**Conductor:**  
 $\phi$  0.2mm<sup>2</sup> - 16mm<sup>2</sup>

Stranded / Flexible  
PV cables with ferrule only

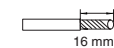

**DIMENSION DRAWING**

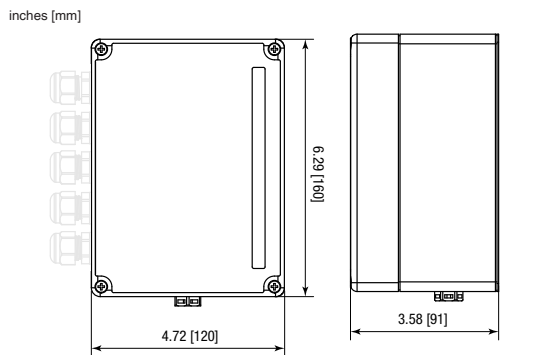

**CONNECTING CABLES**

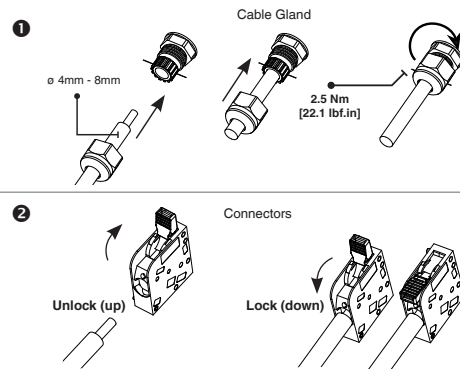

**MOUNTING & PRODUCT DESCRIPTION**

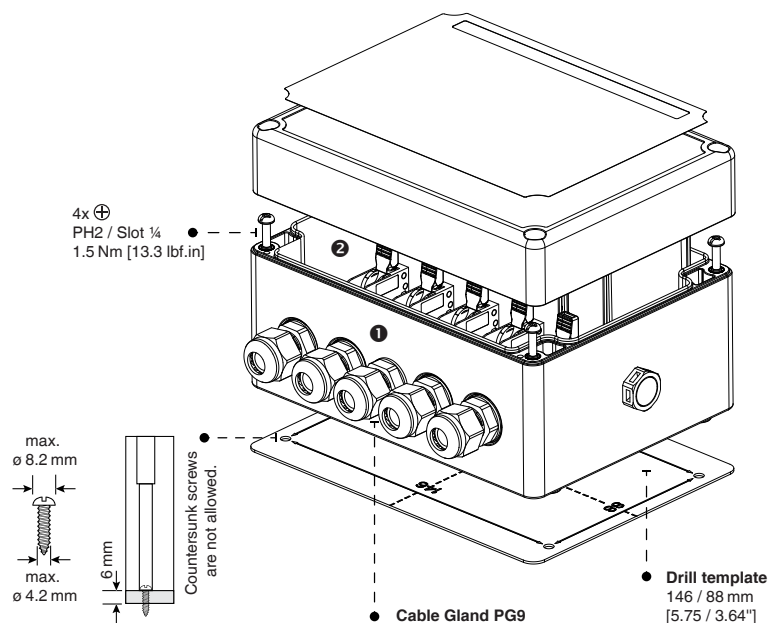

**NETWORK CONNECTIONS**

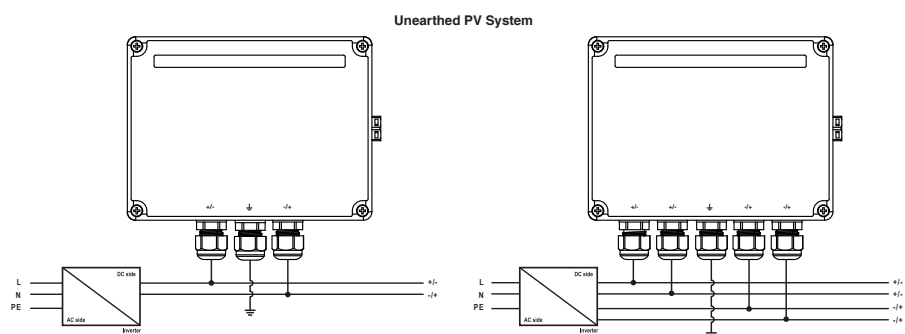

+/- min  $\phi$  6mm<sup>2</sup> [T1], min  $\phi$  2.5mm<sup>2</sup> [T2] ↓, PE min  $\phi$  16mm<sup>2</sup> [T1], min  $\phi$  6mm<sup>2</sup> [T2]

For earthed PV System the wiring is the same, without connecting (-) to PV box.